

**"DMTeh" Ltd. Pleven**

**Fire conventional panel**

**FP 9000**



**Installation, setup and operation.**

**Rev 03:16**

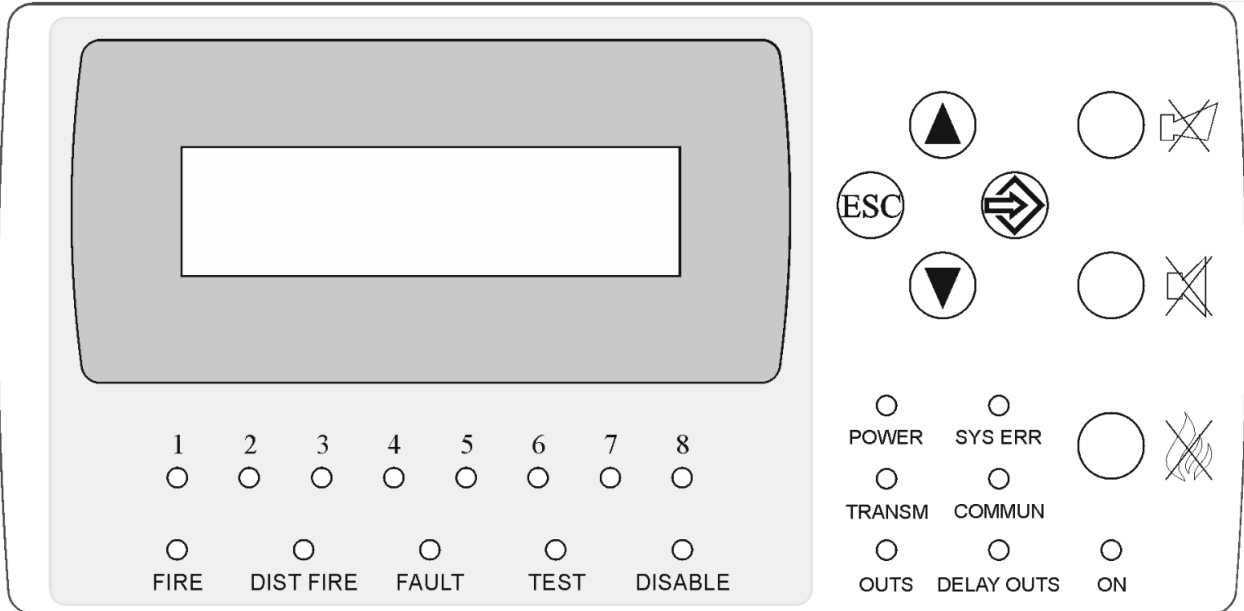
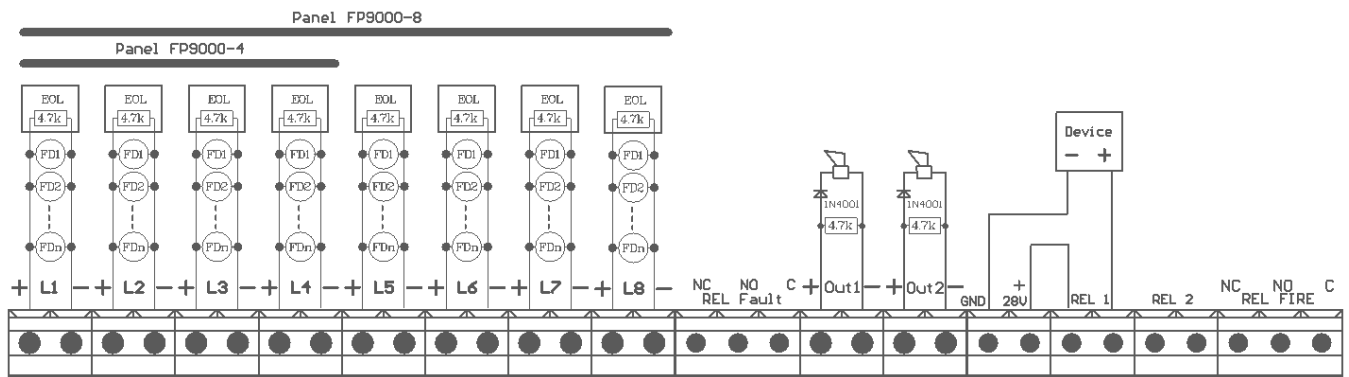

**P. CONTENTS:**

**2 INTRODUCTION**

**2 TECHNICAL PARAMETERS**

**5 CONTROLS AND INDICATION**

**6 FACTORY SET PARAMETERS**

**7 INSTALLATION AND PANEL SETUP**

**14 ACCESS LEVELS**

**16 PANEL CONDITIONS**

**20 CONDITIONS FOR USE, STORAGE AND TRANSPORT**

**21 CONTENT AND COMPLEX OF DELIVERY**

**21 WARRANTY**

## **1. INTRODUCTION**

FP9000 is a conventional Fire alarm panel with 4 or 8 lines. Certified to standards EN 54-2 and EN 54-4. Each line can be connected to 32 detectors. Through the display and keyboard can be programmed and adjusted over 70 functional parameters. Each line has 7 individual programmable parameters and that makes the panel universal for any type of conventional Fire detectors. With its 6 outputs, including 4 programmable, giving flexibility and adaptation to new and existing installations. All the panel conditions information is displayed on LCD 2x16 display and LED indicators. Text message for each zone. Volatile memory and real time clock, enable recording and review of 1200 archive events.

**Quick and easy - installation, setup and starting. Simple and clear procedures for operation and maintenance of the system.**

## **2. TECHNICAL PARAMETERS**

<b><u>LINES</u></b>		
<b>➤ Lines:</b>		
• Number of lines	<b>4 or 8</b>	<b>Optional</b>
• Maximum number of fire detectors in a line	<b>32</b>	
• Type of the joining line	<b>biconductional</b>	
• Plume maximum resistance	<b>100 Ω</b>	
<b>➤ Current thresholds in the lines:</b>		
• Interruption	<b>from 1 to 12 mA</b>	<b>programmable</b>
• Duty mode	<b>from 2 to 60 mA</b>	<b>programmable</b>
• Fire	<b>from 12 to 70 mA</b>	<b>programmable</b>
• Fire direct /without delay outputs/	<b>from 40 to 60 mA</b>	<b>programmable</b>
• Short circuit	<b>&gt; 70 mA</b>	
<b>➤ Lines functional characteristics:</b>		
• Verification quantity before entering Fire mode:	<b>1, 2 or 3</b>	<b>programmable</b>
• Verification and regestrating error if a fire alarm detector is removed:	<b>yes</b>	<b>selectively programmable</b>
• Verification and regestrating fault in a earth conductor	<b>yes</b>	<b>selectively programmable</b>
<b><u>OUTPUTS</u></b>		
<b>➤ Independent relay output in case of fire alarm:</b>		
• Quantity	<b>1</b>	
• Type	<b>switching</b>	<b>NC / NO</b>
• Electrical characteristics	<b>3A/125V AC, 3A/30V DC</b>	
<b>➤ Controllable output in case of fire alarm:</b>		
• Quantity	<b>2</b>	<b>programmable</b>
• Type	<b>potential relay</b>	
• Electrical characteristics	<b>(19-28)VDC/ 0,5A</b>	
<b>➤ Relay output in case of fire alarm:</b>		
• Quantity	<b>2</b>	<b>programmable</b>

• Type	potential-free	<b>NO</b>
• Electrical characteristics	3A/125V AC, 3A/30V DC	
<b>➤ Additional relay outputs (modul M9000R 2/4/6/8) in case of fire alarm:</b>		
• Quantity	2/4/6/8	<b>programmable</b>
• Type	potential-free	<b>NO</b>
• Electrical characteristics	3A/125V AC, 3A/30V DC	
<b>➤ Independent relay output in case of failure:</b>		
• Quantity	1	
• Type	potential-free, switching	<b>NC / NO</b>
• Electrical characteristics	3A/125V AC, 3A/30V DC	
<b>POWER SUPPLY</b>		
<b>➤ Mains power</b>		
• Voltage	<b>(187-252)V AC</b>	
• Frequency	<b>50/60 Hz</b>	
• Maximum power to mains power	<b>65W / AC</b>	
<b>➤ Battery power</b>		
• Battery quantity	<b>2</b>	
• Type of the battery	<b>Lead, gel</b>	
• Battery rated voltage	<b>12V DC</b>	
• Reted power C20	<b>5 Ah</b>	
• Charger voltage	<b>27,6 VDC</b>	<b>temperature compensated</b>
<b>Consumption of battery power in standby mode</b>		
• Configuration with 4 lines	<b>&lt; 55 mA to 24 VDC</b>	
• Configuration with 8 lines	<b>&lt; 75 mA to 24 VDC</b>	
<b>Time needed in security mode when mains power supply is down with battery 12V/ 5Ah</b>		
• Configuration with 4 lines	<b>90h</b>	
• Configuration with 8 lines	<b>72h</b>	
<b>Executive devices powering</b>		
• Voltage	<b>(19-28)V DC</b>	
• Maximal current (including the controllable outputs current)	<b>2A</b>	
<b>Fuses</b>		
• Mains power 230V AC	<b>4,0 A fusible</b>	
• Battery power	<b>6,3 A fusible</b>	
• Powering external devices	<b>1,85 A automatic</b>	
• Controllable outputs	<b>1,1 A automatic</b>	
<b>Functional characteristics</b>		
• Control of the lines and controllable outputs for fault conditions (short circuit and interruption) and automatic reset;		
• Control of the lines for down fire detector and automatic reset;		
• Light and textual indication for Fire, Fault, Prohibition and Test mode;		

• Ability to delay controllable and general outputs for fire for a period of 10 to 600 seconds after the registration of state Fire;	
• Built-in sounder in case of fire – monotonal, continuous with the possibility of exclusion;	
• Test mode of each (fire alarm) lines;	
• Ability to Disable each of the fire alarm lines;	
• Ability to Disable controllable outputs for fire;	
• Interface for communication with external devices RS485 and networking / optional /;	
• Possibility for GPRS communication and remote control and monitoring / optional /;	
• LCD display, 2×16 characters and keyboard, for control and panel indication;	
• Energy independent archive of the events, recorded by the panel, consisting of type, date and time of the event - to 1200 events;	
• Fire counter - up to 9999 registered fire conditions;	
• Choice of language for text information display;	
• A set of test modes and options for adjustment of lines, outputs and panel.	
➤ <b>Over all size</b>	<b>310x240x80 mm</b>
➤ <b>Weight without batteries</b>	<b>1,3 kg</b>
➤ <b>Safety degree</b>	<b>IP30/ EN 60529</b>
<b>The panel meets standarts:</b>	
• EN 54-2:1997	
• EN 54-2:1997/A1:2006	
• EN 54-2:1997/AC:1999	
• EN 54-4:1997	
• EN 54-4:1997/A1:2002	
• EN 54-4:1997/A2:2006	
• EN 54-4:1997AC:1999	
• EN 50130-4:2011	
• EN 55022:2006/A1:2007	
• EN 60950-1:2006/A11:2009	





### **3. CONTROLS AND INDICATION**



#### ➤ **LED indicators**

Indicators	Function
<b>“POWER”</b>	Constant green light
<b>“FIRE”</b>	Common indicator - flashing or constant red light in Fire condition
<b>“DIST FIRE”</b>	Flashing or continuous red light in case of a remote station Fire while working in a network of more than one panel.
<b>“FAULT”</b>	A common failure indicator. Upon failure of any type a yellow light will start flashing
<b>“SYS FAULT”</b>	A system failure due to stoppage of the CPU. A constant yellow light will

	light up. Needs to be repaired at an authorized service.
“POWER FAULT”	In case of fault or loss of an AC or battery power supply a steady yellow light will light up.
“TEST”	When in line test condition a constant yellow light will light up.
“DISABLE”	When in Disabled component / line or controllable output / a steady yellow light will light up.
“OUTS”	Illuminates with steady yellow light at short or interruption of output devices power supply line
“DEL OUTS”	Continuous yellow light at preset delay of connected outputs
“BUZZER SILENCE”	Indicator to the button "BUZZER SILENCE", in suppressing local telltale, a steady red light will light up.
“SOUND SILENCE”	Indicator to the button "SOUND SILENCE", when suppressing Fire outputs, a steady red light will light up.
“COMUN”	При повреда на устройството за предаване на данни по RS485, свети с постоянна жълта светлина. When of the for data transmission device failure by RS485, a constant yellow light will light up.
“TRANSM”	In case of device failure, will transmit a Fire alert to a remote center.
“1 2 3 4 5 6 7 8”	Individual indicators for Fire and line failure - Fire is lit with red light, fault lights up with yellow light. When disabled and line test there is an indication of the respective condition.

➤ **BUTTONS**

Button	Panel condition	Access level	Действие на органа за управление
	Fire	Level 2	Exit from Fire condition.
	Fire	Level 2	Where activated outputs for Fire - silence of the same outputs.
	Fire и Failure	All Levels	Suppression / activation of the local sounder
	Охрана, Fire, Failure, Test and Disable component	Levels 1 and 2	Entry in Information and management condition.
	Information and management	Levels 1 and 2	- Displaying the next element onto the display; - Moving of the cursor; - Modification of the selected parameter.

	Fire	Levels 1 and 2	- Displaying the previous text message for Fire onto the display.
	Information and management	Level 1 and 2	- Displaying the previous element onto the display;
	Options	Level 3	- Modification of the selected parameter.
	Fire	Levels 1 and 2	Displaying the next message for Fire onto the display
	Information and management	Levels 1 and 2	- Displaying the next element from the menu onto the display;
	Options	Level 3	- Moving of the cursor; - Modification of the selected parameter.
	Information and management	Levels 1 and 2	- Exiting a function without saving changes in parameter -no command execution; - Exiting from the current menu and transition to the upper menu in the hierarchy.

#### **4. DEFAULT PARAMETERS**

The fire panel provides users with default parameters, described in the table below. These parameters are saved and recorded from menu "Default par."

<b><u>INPUT LINES</u></b>		
<b>➤ Lines:</b>		
• Quantity	<b>4 or 8</b>	
<b>➤ Current thresholds in the lines:</b>		
• Interruption	<b>from 4 mA</b>	
• Duty mode	<b>from 5 to 16 mA</b>	
• Fire	<b>from 17 to 70 mA</b>	
• Fire direct /without delay outputs/	<b>from 40 to 70 mA</b>	
• Short circuit	<b>&gt; 70 mA</b>	
<b>➤ Lines' functional characteristics:</b>		
• Verification quantity before entering in fire state:	<b>2</b>	<b>programmable</b>
• Verification and registering error if a fire alarm is removed:	<b>Off</b>	<b>selectively programmable</b>
• Verification and registering fault in a earth conductor	<b>On</b>	<b>selectively programmable</b>
<b><u>OUTPUTS</u></b>		
<b>➤ Independent relay output in case of fire alarm:</b>		
• Quantity	<b>1</b>	<b>EN 54-2, independent</b>
<b>➤ Programmable controllable output in case of fire alarm:</b>		
• Quantity	<b>2</b>	<b>Not connected to zones</b>
<b>➤ Programmable relay output when fire alarm:</b>		
• Quantity	<b>2</b>	<b>Not connected to</b>

		zones
<b>➤ Independent realy output during failure:</b>		
• Quantity	1	<b>EN 54-2, independent</b>
Functional characteristics		
• Controllable and general outputs delay in case of fire. (The delay is valid only when outputs are connected to zones )	60 seconds	

## 5. PANEL INSTALATION AND SETUP

### 5.1 Panel assembly.

- Unpack the panel;
- Mount the dowels at the appointed place for fixing the panel;
- Attach the panel to the dowels through the three holes on the chassis

It is recommended that the panel should not be installed near heat sources (radiators, air conditioners, etc.).

- The connecting wires are mounted, using the hole in the box.

### 5.2. Connecting Fire detectors.

➤ **Fire detectors are installed** to the panel with the help of two-wire insulated line of total resistance up to 100Ω. The recommended conductor cross-section is depending on the length of the lines, which are:

- |                |                               |
|----------------|-------------------------------|
| ◆ Up to 1000 m | cable 2 x 0,5 mm <sup>2</sup> |
| ◆ Up to 1500 m | cable 2 x 1,0 mm <sup>2</sup> |

Upon accession to the Fire alarm line to the panel, a check on the resistance is recommended. In case of proper installation in one line (fitted with finite element) between the plus and minus of the cable entering the panel, resistance should be measured 4,7k (+/-10%). When measuring the two wires to "Earth", there should not be a link.

The connection is made to the terminals of the relevant modules - "+Lx" and "-Lx" (where "x" is the line number) when observing the indicated polarity. (Fig.1)

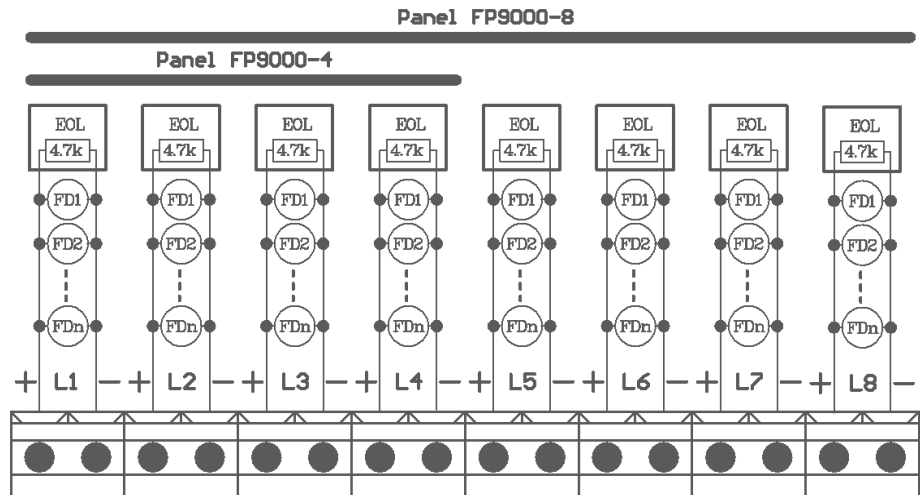



Fig.1

One line can allow the installation of up to 32 Fire detectors generally, regardless of their type. To the unused lines, directly to the terminals mount the final element "EOL", otherwise the lines will be able in Fault condition.

➤ **Removed Fire alarm detector function.**

The panel is capable of registering the damage when Fire alarms detectors are maliciously removed. To use this function :

- Enable the "Fault removed detector" function when programming the parameters of the Fire lines. This function is activated for each line separately. (see below The Fire alarm lines programming and setting)
- The basics to mount diode towards providing current flow of shunting contacts of the Fire alarm detector. (Fig.2). If the diode is not specified by the manufacturer of the Fire alarm detector, we recommend using a Schottky diode 1N5819 or equivalent.

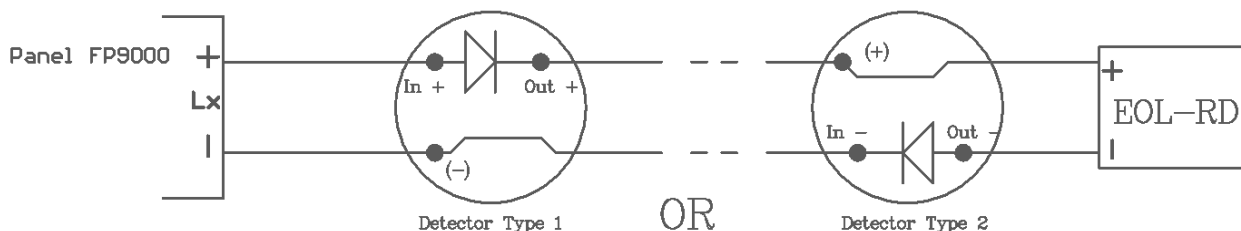
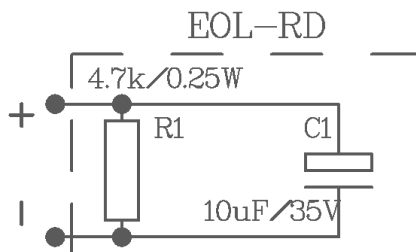

Fig.2

- The EOL to be type EOL-RD. (Fig.3). To the resistor 4,7k / 0,25W, add parallel electrolytic capacitor 10uF/35V. Be careful to observe polarity when connecting "+" and "-" of the electrolytic capacitor. Finite element EOL-RD can be ordered from DMteh Ltd.



фиг.3

➤ **FIRE LINES - Parameters programming and setting.**

For each Fire line individually, through the menus of the panel, there is an opportunity to set the following parameters:

- **Current interruption**  
It can change the current interruption from 1 mA to 12 mA. The factory setting is 4 mA. The feature gives flexibility in installation of the panel, both existing installations and new, with sensors and final elements of any type.
- **Current Fire**  
The limit current of Fire condition can be varied from 12 mA to 60 mA. The factory setting is 16 mA. The function enables the use of conventional Fire alarms detectors of any type and manufacturer.
- **Number of checks**

The setting provides a choice of 1, 2 or 3 checks before the line to enter the condition "Fire." The default setting is for 2 checks.

- When setting up with 1 check, panel enters Fire condition immediately after activation of the Fire alarm. This setting is recommended for lines with MCP.
- When setting up 2 alarms. After the first activation, the panel resets the line for 3 seconds and awaits a second response in the next 60 seconds. If there is a response in this period the panel enters Fire condition. This setting is recommended for lines with automatic Fire detectors the aim of ignoring false alarms.
- When setting up to 3 alarms. After the first activation, the panel resets the line for 3 seconds and awaits a second response in the next 60 seconds. If there is a response in this period, the panel again resets the line for 3 seconds and awaits for the third activation in the next 60 seconds, if any, the panel enters Fire condition. This setting is also recommended for lines with automatic fire detector for greater security when the Warning and extinguishing.

- **Removed Fire alarm detector**

The setting allows for inclusion and exclusion of the registration of fault function in case of maliciously removed Fire alarm detector. The default checking is off. If this function is used, keep in mind the above-described installation of the Fire alarms detectors.

- **Outputs**

To each line can be joined 4 programmable outputs, that will be activated when Fire condition of the respective line. The panel has two controllable potential relay outputs and two potential-free relay. The factory setting is without the connected outputs. Depending on the project and the type of object, join the necessary outputs.

- **Delay Outputs**

For each line has the ability to set a delay to trigger the outputs, that are connected to it. It is possible of a delay of 0 to 600 seconds. The election takes place every 10 seconds. If it is 0 we have direct actuation. The factory setting for all lines is 60 seconds. The delay is only active when there are connected programmable outputs. The function allows for each guarded line to determine individual time for a physical check to the secured area for authentication alarm. The aim is for the time to be enough to check the area and return to the panel for a possible reset to Fire condition and in case of spurious actuation, to prevent inclusion of sirens and executive devices.

***Example:***

***If you have an object of 4 floors with panel located on the first floor, it can be given for example the following location and time parameters:***

***1 and 2 line guard the 1st floor - time to view 80 sec.***

***2 and 3 line guard the 2nd floor - time to view 120 sec.***

***4 and 5 line guard the 3rd floor - time to view 170 sec.***

***6 and 7 line guard the 4th floor - time to view 240 sec***

In this configuration, the outputs, which are connected to the respective lines, are set delays consistent with the time to view.

In Fire condition two lines with different delay, it is automatically chosen the lower set value of delay.

- **Text message**

For each line via the display keys it can be put in a text message up to 15 characters per line/area. This message appears on the display when in Fire condition of the respective line and indicate the area of security of therespective line.

### 5.3. Installation of the executive devices at panel

All connections are made by means of terminals, mounted on the printed circuit board (Fig.4).

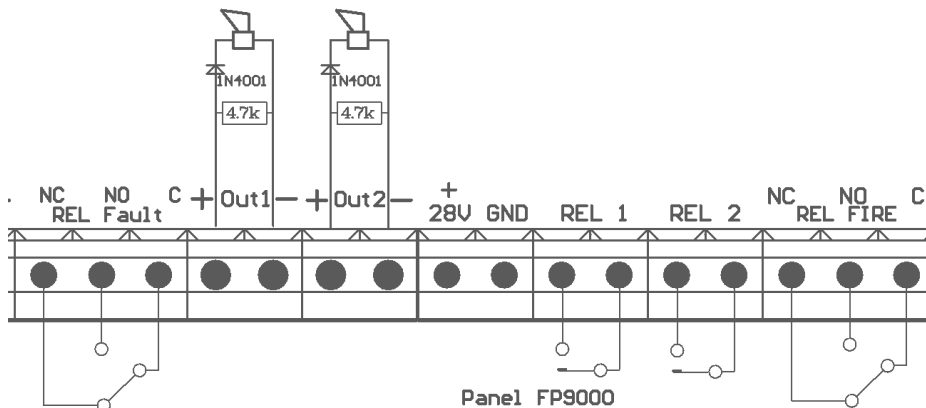

Fig. 4

Total consumption of the voltage powering the external devices (terminal "+28 VDC") and the consumption of the controllable outputs shall not exceed 2,0 A in the heaviest mode.

#### 5.3.1. Installation of the executive devices to the panel’s controllable outputs.

Terminals "+ Out x", "-Out x" - controllable, potential outputs, responding at Fire condition, are used. At the end of the line a resistor 4,7k/0.25W (from the design of the panel) is mounted. It is recommended that in series with the power supply of the corresponding device to place a diode (Fig.5). We recommend 1N4001 diode or equivalent. The panel constantly monitors for failure (interruption or short circuit) power line devices.

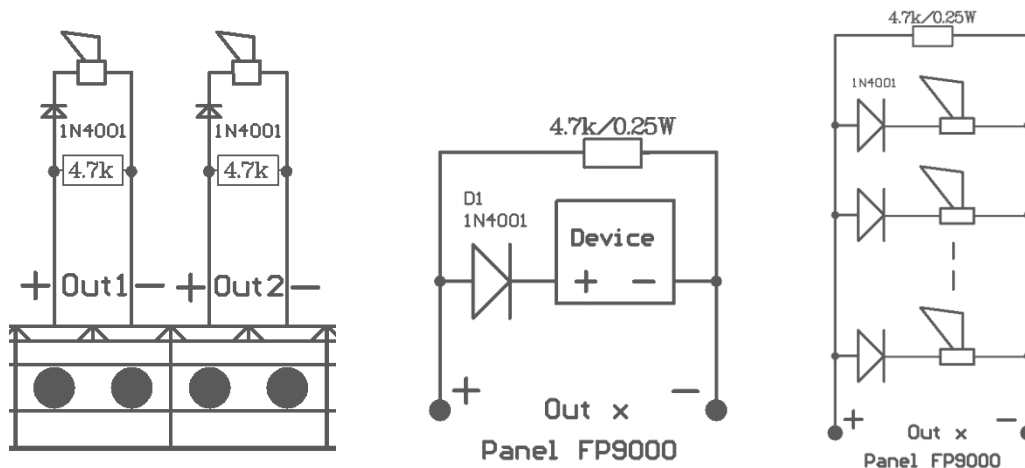

Fig. 5

If controllable outputs are not used, directly to terminals "+Outx", "-Outx" a resistor 4,7k/0,25W is connected, otherwise the outputs will be in Fault condition.

### 5.3.2. Installation of the executive devices to RELAY OUTPUTS.

Used:

- Terminal "+28VDC" - positive lead of the stabilized direct voltage for external devices (light and sound signaling devices, executive devices, etc. );
  - Terminal "GND" – (negative lead for supplying the external devices);
  - Terminal of the corresponding relay outputs.
- Relay outputs with changeover contacts for **Fault (REL Fault)** and **Fire (REL Fire)** conditions.
- When in Fault condition of the panel, output - **REL Fault**, is activated immediately, regardless of the type of fault. The output may not be disabled or delayed.
  - Upon entering the panel's condition **Fire**, no matter what line, output - **REL FIRE** be activated immediately. The output may not be disabled or delayed.

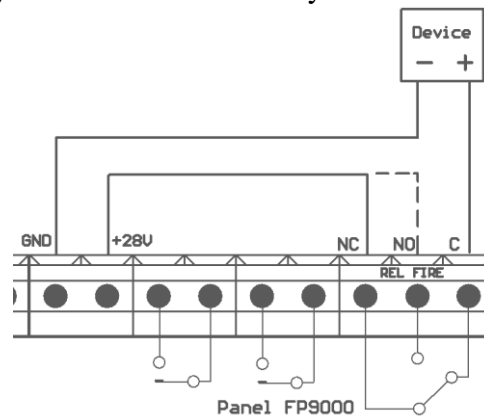

Fig. 6

- **REL Fault** - terminals "REL Fault/C", "REL Fault/NO" and "REL Fault/NC" - potential free relay contacts of the relay. In the absence of failure, there is a link between terminals "REL Fault/C" and "REL Fault/NO", and in case of failure - between terminals "REL Fault/C" and "REL Fault/NC".
  - **REL FIRE** - terminals "REL FIRE/C", "REL FIRE/NO" and "REL FIRE/NC" - potential free relay contacts of the relay. In standby mode there is a connection between terminals "REL FIRE/C" and "REL FIRE/NC " and in case of Fire - between terminals "REL FIRE/C" and "REL FIRE/NO ".
- Programmable relay outputs in **Fire (REL 1)** and **(REL 2)**.  
 The terminals of the relay outputs are - potential free relay contacts of the relay. In standby mode there is no connection between terminals, but when joining the output to line and Fire condition in the same line, a connection is made by the relay contacts, which are displayed on terminals.

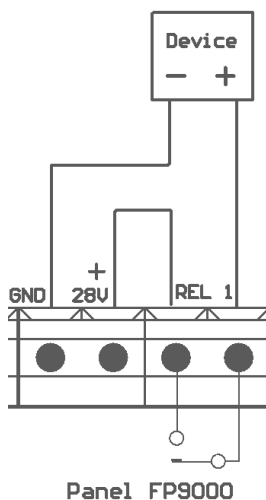

Fig. 7

➤ **Fire alarm lines' function "AND"** scheme with using relay outputs (REL 1) and (REL 2).  
 If the panel is used to control the **putting out** or other automatic devices requiring high security in case of Fire alarm, it is recommended to realize the 2 Fire alarm lines' function "AND" (only two lines in Fire activates output). Used following scheme:

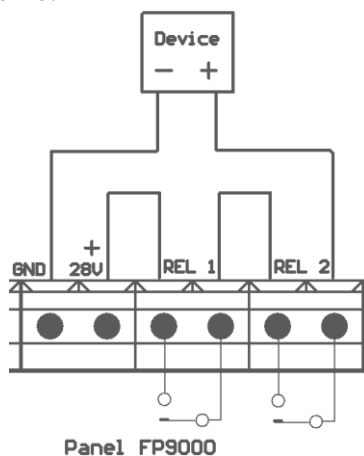

Fig. 8

A necessary condition is that both outputs must be connected separately, the two lines only. (In case of Fire on one line to be activated REL 1 and Fire in the other line - REL 2 ). Joining the outputs is done by the Lines setting menu.

If relay outputs are not used, then its terminals remain free (nothing is connected to them).

➤ **Outputs - Programming and parameter setting outputs for executive devices.**

**Relay outputs:** REL Fault and REL FIRE are automatic and not subject to programming, prohibition and delay.

- **Programmable relay outputs** Fire (REL 1 ) and (REL 2 ), programmed from menu “Lines setting” (see above "Programming and setting the Fire alarm lines " ). They can join any line as well as can be set a delay for each line individual activation. Outputs (REL 1 ) and (REL 2 ) **cannot** be prohibited.

- **Controllable programmable outputs** Fire (Out 1) and (Out 2) are programmed from the Line settings menu (see above "Programming and setting the Fire alarm lines"). They can join each line and it can be set a delay for a delay for each line individual. Outputs (Out 1) and (Out 2) **can** be prohibited. When prohibited the supply line for damages is not monitored and the output is not activated.

#### 5.4. Power supply connection

To the terminal with mains fuse connect feeding cable observing the following positions.

- P - power wire " Phase";
- N - power wire " None ";
- "Earth" - safety ground wire.

The cable should be double insulated and section not less than 0,5 mm<sup>2</sup> for power cables and 1,5 mm<sup>2</sup> for the safety ground wire.

The other end of the feeding cable is connected to the mains using a junction box.

The mains power supply of the panel should be on a separate circuit.

### 6. PUTTING THE PANEL IN WORKING CONDITION

- Check the connection to mains power supply.
- Check the correct connection of peripheral devices.
- Place the fuse in the terminal.
- С него се следи температурата и се контролира режима на заряд на акумулаторите. Join the feeding cables to the batteries, where as the batteries are connected in series. To the positive terminal of the battery join the red wire and the negative – to the blue wire. The overall voltage of both batteries must be greater than 17,6 V, otherwise the panel does not recognize them. Thermal sensor in the panel place in the battery. With it you monitor the temperature and control the mode battery charge.
- If everything is done correctly and the lines parameters are within the factory settings, the panel enters Duty Mode.
- Do a check of current in all lines from the "Electricity lines" menu from the main menu. The standby current is recommended to be from 2mA to 5mA set over the current interruption.  
*Example: The factory settings are with current interruption 4 mA, when a measurement of current in standby condition is done, line is recommended to be from 6 mA to 9 mA.*  
If using linear, non-standard and other Fire alarms detectors, it is necessary to adjust the currents break and Fire, so that the panel can be able to recognize them correctly.
- Set the accession of exits and the respective delays, if they are necessary.
- If necessary, program and adjustment to other parameters of the panel and the lines from the respective menus. The programming of parameters can be done before connecting the wires of lines and outputs.
- If necessary, adjusts the clock for real-time of the panel.
- Reset archive events.

### 7. LEVELS OF ACCESS

В централа FP9000 са реализирани **4 LEVELS** на достъп на различните индикации и управляващи функции. In panel FP9000 There are **4 LEVELS** of access to the various indications and control functions.

#### ➤ Access Level 1

This level of access is for all persons, whom can be expected to identify and react to Fire alarm or

fault. Visible are all light indicators.

Available are the following features:

- suppression of built sounder;
- displaying suppressed messages for Fire, Fault and Disabled components;
- displaying the status of the lines;

➤ **Access Level 2**

This is a level of access to persons, who are responsible for the safety and are trained and authorized to operate the panel in the conditions:

- Security;
- Fire;
- Fault;
- Disabled component;
- Test.

In access level 2 are available are following features:

- Exit from Fire condition;
- suppression of the outputs, activated when Fire;
- involuntary activation of the controllable outputs;
- suppression of built- in sounder.

Switching from **Level 2 to Level 1 and vice versa** happens after a combination of buttons and the relevant information on the display.

The selection happens from the second menu of the main menu - " Access Level ".

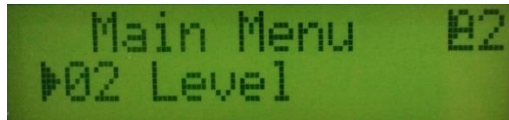

After entering the menu, with button «Enter» and the corresponding buttons up and down choose the level. Confirm again with «Enter».

The selected level, in Security/Duty mode, is displayed in the upper right corner of the display.



➤ **Access level 3**

In Level 3 is reached by entering a password and opening the front cover of the panel.

Available are the following panel's features:

- all possibilities from Levels 1 and 2
- Replacing a burnt fuse;
- on / off communication through interface RS485;

➤ **Access Level 4**

This is the level of access for persons who are trained and authorized by the manufacturer to repair the panel and modify the software.

Special means are required to enter this level.

## 8. CONDITIONS OF PANEL

FP9000 panel operates in five conditions: Duty, Fire, Fault, Disabled component and Test.



### 8.1. DUTY CONDITION

In Security condition, the panel is ready for indication and treatment of Fire and Fault conditions in case of relevant events.

- **LED indication** – light up the indicator: "POWER" and "DEL OUTS" at preset delay of connected output.
- **Beeper indication** - off.
- **Text message indication** - displayed labeled " Security " and information about the current time.
- **Active buttons** - button . When you press it the panel enters Information and Control condition.

### 8.2. FIRE CONDITION

Централата може да бъде в състояние Fire по една или по няколко линии.

- The panel may be in Fire condition in one or several lines.
  - **LED indication** - light indicators:
    - "FIRE"
    - "1 2 3 4 5 6 7 8" Local indicator(s) for Fire in a line.
- **Beeper indication** - Sounder is constantly on.
- **Text messages** - Text information about the lines in Fire are displayed on the display:
- **Active buttons**
  - button "**BUZZER SILENCE**". Pressing it leads to:
    - **Disabling** the embedded sounder, if it has responded to Fire or Fault;
    - **Activating** the built-in sounder, if the panel is in Fire or Fault condition and the tone is disabled by previous pressing of the same button.
  - button "**SOUND SILENCE**". Press it to :
    - When suppressed outputs for Fire - forced activation of the outputs;
    - When activated outputs for Fire - suppression of these outputs.
  - button "**RESET**". Press it to :
    - the panel is forced to exit Fire condition and reset lines ( power down for 3 seconds).
  - buttons  and . Pressing them leads to:
    - Displaying suppressed messages display lines in Fire.
  - buttons . Press it to :
    - Entering in Information and Management condition.

### 8.3. Fault Condition

Panel enters Fault condition when registering any of the following events:

- Fatal system fault;
- Low power - diluted battery during dropping in the mains supply;
- Fault in a line - removed Fire alarm detector, short circuit or break;
- Fault in a controllable output - short circuit or break;
- Damage to the mains;
- Fault in backup batteries;
- Short circuit or leakage to ground wire;



- Fault in power lines;
- Fault in power supply for external devices;
- Fault in network or transmission device.

When systemic failure processor can not continue.

Exit for this kind of fault can only be accomplished by turning off the power and subsequent repair.

All damage, except for the system kind, lead to switching off some periphery.

Exiting this condition happens automatically to 100 seconds after dropping out (removal) of the fault.

When in fault "Low power" the built-in sounder is activated with discontinuous signal.

- **LED indication** – lights up the indicator : "**FAULT**" and depending on the fault :
  - Upon System error - indicator "SYS FAULT" lights up in continuous yellow light;
  - Upon fault in Fire alarm line - individual fault indicator flashes yellow light respectively when:
    - short circuit - with a frequency of 1 Hz ( slow flashing );
    - interruption - a frequency of 4 Hz ( fast flashing );
    - removed Fire alarm detector - a frequency of 4 Hz, every one second (choppy rapidly flashing).
  - Upon fault in a controllable output - indicator "OUTS" lights up with flashing yellow light;
  - Upon fault in mains supply - indicator "POWER FAULT" lights up in continuous yellow light;
  - Fault in the local network or the transmission device - indicator "COMUN" lights up with a steady yellow light.
  - If the sound signal is suppressed by button "BUZZER SILENCE", LED indicator lights up a constant red light.
- **Beeper indication** – The built-in sounder is activated with a discontinuous signal.
- **Text messages indication** - Text messages for fault condition are displayed by priority on the main display screen.

If we have more than one failure, by button  and regulating buttons enter the menu "FAULT". In this menu you can see all registered damage.

- **Active buttons**
  - button "**BUZZER SILENCE**". Pressing it leads to:
    - **disabling** the embedded sounder, if it is activated by Fire or Fault;
    - **activating** the built- in sounder, if the panel is in Fire or Fault condition and the annunciator is disabled by previous pressing the same button.
  - button . When you press it, the panel enters Information and Control condition.

#### **8.4. DISABLED COMPONENT CONDITION**

Panel enters **Disabled component** condition after a manual operation of disabling a specific component - a Fire alarm line and/or controllable output. The condition is managed through the information and control screens. The menu «**PROHIBITION**» is third from the main menu.

After selecting the relevant line and/or controllable output with buttons, switch the conditions "**on**" and "**off**", respectively for disabled function on and off.

The forbidden line is off (not supplied) and it is not controlled for activated Fire alarm and Fault. The disabled controllable output is switched off (the executive device can not be activated) and is not monitored for failure.

- **LED indication** - light indicators:
  - "DISABLE" lights up with a constant yellow light
  - "1 2 3 4 5 6 7 8" local line indicator lights up with flashing yellow light.
  - "OUTS" flashes when a disabled controllable output.
- **Beeper indication** - not affected by the disabled component condition.
- **Text messages indication** - Information about the lines and controllable outputs in Disabled, are displayed on the display. When "on" we have a disabled component in "off" active.
- **Active buttons**
  - buttons . Press it to :
    - Enter Information and Management condition.

## **8.5. TEST CONDITION**

Panel enters Test condition through manual operation for setting a Fire alarm line in to test. The condition is managed through screens of Information and control condition. Menu «**Test Lines**» is fourth from the main menu.

After selecting the respective line, with the button switch conditions "on" and "off", respectively, on and off Test function.



When inserting the line test, the following changes are in effect:

Upon registration of Fire event in the line, sound and light indications and associated controllable and relay output for failure are not activated, ie the panel does not enter Fault Condition:

- Events in the line are not saved in the energy independent archive;
- The line is reset (shuts off its power supply for time 3sec) automatically every 60s.
- **LED indication** - light up indicators:
  - "TEST" is lit with yellow light
  - "1 2 3 4 5 6 7 8" local line indicator in Test lights up with flashing yellow and red light.
- **Beeper indication** - is not affected by the of the Test condition lines.
- **Text messages** - Information on the lines in Test are displayed on the display. When "on" we have a line in Test and when "off" - no line in Test.
- **Active buttons**
  - buttons . Pressing them leads to:
    - Entering Information and Management condition.

### **8.5.1. TEST LED**

#### **Testing of LED indication the panel done by menu «Test indication».**

With button  activate the illumination of all LEDs. The exception is the indicator for systemic failure that should not be on. With button  start the test. If button  is not pressed, the panel automatically enters Duty condition after 30 seconds.

## **8.6. INFORMATION AND CONTROL CONDITION**

The panel has a display and keyboard to check the parameters, settings, monitoring and changing conditions, displaying archives of events and etc. From the menus can be selected more than 100 active screens for setup and management of the panel.

By menus you can perform the following actions:

**Main menu:** /access level 1 or 2/

- View all the zones in Fire;
- View all the failures;
- Change the access level from 1 to 2 and vice versa;
- Review and launch (at access level 2) of the Disable condition;
- Review and launch (at access level 2) of the Test in line condition;
- Review of current current in the Fire alarm lines.

**System features:** /Access Level 2/

- Test indication;
- Setup the real-time clock, year, month, day, hour, minute, second, correction;
- Check on the Fire counter;
- View the archive of events; /up to 1200 events/

**Setting:** /Access level 2 + password/

- Setup the parameters of the panel : Language, Network address and on / off function to check for ground wire failure;
- Lines' Setting. For each line we have separate settings: Electricity interruption, Electricity of Fire, Number of checks to enter the condition Fire On. / Off. function to check the damage Removed Fire alarm detector, Joining outputs to the line / area, delay activation of outputs after registering the condition Fire, text message for each zone;
- Input factory settings menu;
- Change the password to access the setup menu;
- Delete archive.

### **! When working with menus to have the following characteristics.**

- When working with menus, use the four active buttons for information and management. (see Controlsfor management and indication).
- If you enter into the menu,s structure and has no activity for more than 30 seconds, it automatically returns to Duty mode.
- If you can not enter into a menu, check whether the access level is set properly.
- Please note that Setting Mode stops processing the Fire alarm lines.
- After exiting from the Setup menu the panel goes through reset and record the new set parameters.

## **9. CONDITIONS FOR USE, STORAGE AND TRANSPORT**

### ➤ **Operation and storage**

The panel is used and stored in closed rooms under the following conditions :

### ➤ **Temperature**

- |             |      |               |
|-------------|------|---------------|
| - storage   | from | 5°C to 35°C   |
| - transport | from | -10°C to 50°C |
| - working   | from | -5°C to 40°C  |

- **Relative humidity**
  - storage to 80%
  - working to 93%

- **Transport**

The panel is transported in covered vehicles, in factory packing and in the above atmospheric conditions.

## **10. DELIVEERY COMPOSITION AND COMPLEXITY/SET**

• Fire Station FP 9000	<b>1 qty.</b>
• EOL - resistor 4,7kΩ/0,25W:	
- for configuration with 4 lines /FP9000-4/	<b>4 qty.</b>
- for configuration with 8 lines /FP9000-8/	<b>8 qty.</b>
• (EOL)End for controllable output - resistor 4,7kΩ/0,25W;	<b>2 qty.</b>
• Fuse 6,3A;	<b>1 qty.</b>
• Fuse 4,0A;	<b>1 qty.</b>
• Connective bridge for batteries;	<b>1 qty.</b>
• Packaging.	<b>1 qty.</b>

## **11. WARRANTY**

The manufacturer guarantees the product's conformity with EN 54-2: 1997, A1: 2006, EN54-4: 1997, A1: 2002, A2: 2006. The warranty period is 24 months from the date of sale, provided that:

- the conditions of storage and transport were met;
- the startup has been done by authorized persons;
- The requirements for operation conditioned in this instruction were met;
- Defects are not caused by natural phenomena and accidents of thr plug socket.

*DMTeh wishes you splendid work!*

**For any questions may contact the company's technical staff DMTeh, by email.**

e-mail : [office@dm-teh.com](mailto:office@dm-teh.com)